

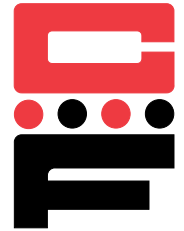

Self-Clinching Panel Fastener



Series CPFC2

CPFC2 panel fasteners provide permanent attachment of screw assemblies to removable sheet metal panels. Pre-assembled screw assemblies remain captive for easy mounting and removal of panel.

Series	Material	Finish
CPFC2	300 Series Stainless Steel	Passivated ASTM A967

Thread: External 2A, ANSI B1.1 (6g, ANSI/ASME B1.13M).

Use in: Materials with Rockwell Hardness B-70 or less.

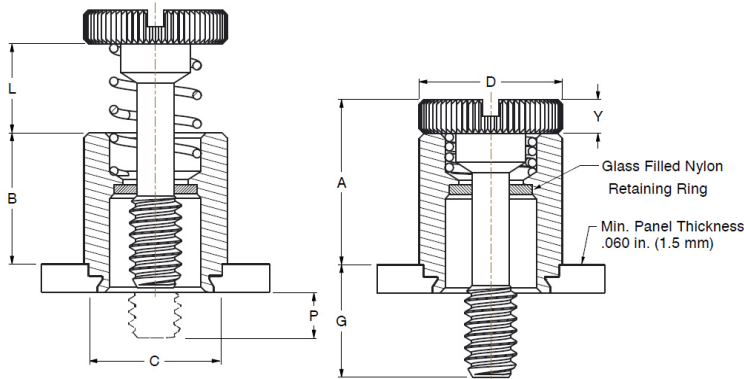

Part Number Structure:

CPFC2 440-40

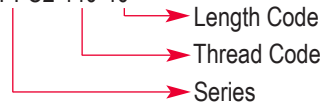

Dimensions & Specifications

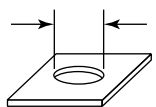
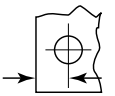
Thread Size	Part Number	G ±.016	P ±.016	L ±.016	D +.016 -.010	A Max.	Y ±.005	B ±.010	C Max.	 +.003 -.000	 Min.
#4-40	CPFC2440-40	.250	.000	.19	.312	.36	.072	.28	.264	.265	.25
	CPFC2440-62	.375	.125								
	CPFC2440-84	.500	.250								
#6-32	CPFC2632-40	.250	.000	.19	.344	.36	.072	.28	.280	.281	.28
	CPFC2632-62	.375	.125								
	CPFC2632-84	.500	.250								
#8-32	CPFC2832-50	.312	.000	.25	.375	.45	.082	.36	.311	.312	.31
	CPFC2832-72	.437	.125								
	CPFC2832-94	.562	.250								
#10-32	CPFC21032-50	.312	.000	.25	.406	.45	.082	.36	.343	.344	.34
	CPFC21032-72	.437	.125								
	CPFC21032-94	.562	.250								
1/4-20	CPFC2420-60	.375	.000	.31	.468	.58	.097	.47	.412	.413	.38
	CPFC2420-82	.500	.125								
	CPFC2420-04	.625	.250								

Continued on next page.





Self-Clinching Panel Fasteners

Series CPFC2





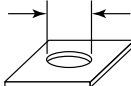

Continued from previous page.

Dimensions & Specifications

		Thread Size	Part Number	G	P	L	D	A	Y	B	C		
				±.4	±.4	±.4	+. -.25	Max.	±.13	±.25	Max.		
METRIC (mm)	M3 x 0.5	CPFC2M3-40	6.4	.0	4.8	7.92	9.14	1.83	7.2	6.71	6.73	6.35	
		CPFC2M3-62	9.5	3.2									
		CPFC2M3-84	12.7	6.4									
	M4 x 0.7	CPFC2M4-50	7.9	.0	6.4	9.53	11.43	2.08	9.3	7.9	7.92	7.87	
		CPFC2M4-72	11.1	3.2									
		CPFC2M4-94	14.3	6.4									
	M5 x 0.8	CPFC2M5-50	7.9	.0	6.4	10.31	11.47	2.08	9.3	8.72	8.74	8.63	
		CPFC2M5-72	11.1	3.2									
		CPFC2M5-94	14.3	6.4									
M6 x 1.0	CPFC2M6-60	9.5	.0	7.9	11.89	14.73	2.46	12.0	10.47	10.49	9.65		
	CPFC2M6-82	12.7	3.2										
	CPFC2M6-04	15.9	6.4										

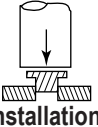
Installation & Performance Data

		Cold-rolled Steel		5052-H34 Aluminum	
		 Installation Force (lbs.)	 Pushout (lbs.)	 Installation Force (lbs.)	 Pushout (lbs.)
INCH (in.)	#4-40	3000	300	2400	240
	#6-32	3500	350	2700	275
	#8-32	3800	400	2900	300
	#10-32	4000	500	3000	400
	1/4-20	5000	600	3500	400
		(kN)	(N)	(kN)	(N)
METRIC (mm)	M3	13.3	1334	10.7	1068
	M4	16.9	1779	12.9	1334
	M5	17.8	2224	13.3	1779
	M6	22.2	2669	15.6	1779